

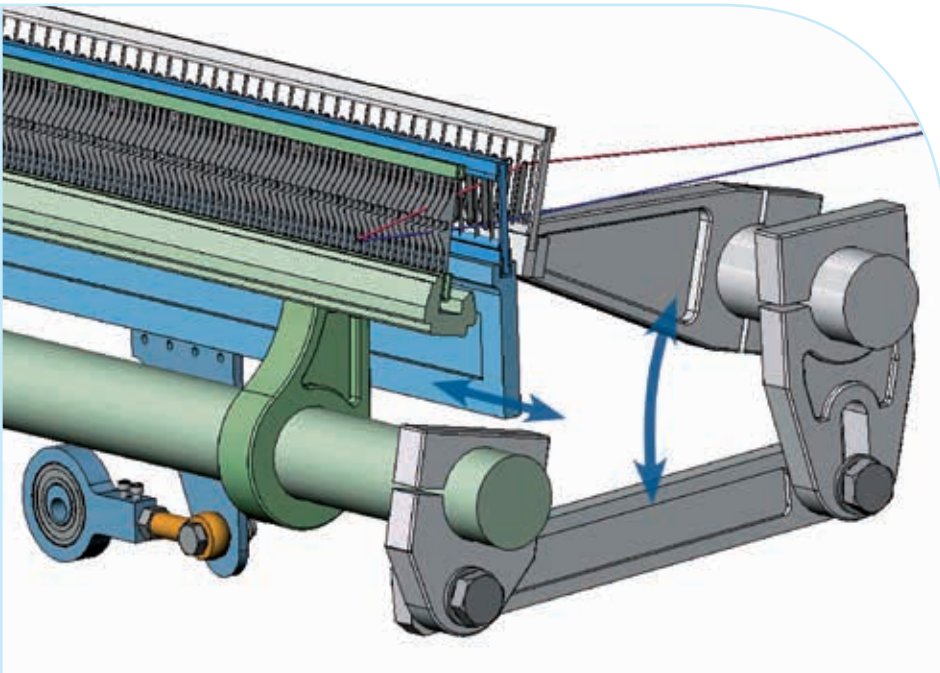

# A TOUCH OF DORNIER

Various final products produced using the "drebbling" technique on DORNIER air-jet and rapier weaving machines with DORNIER EasyLeno® and DORNIER EasyLeno®-2T.

## DORNIER EasyLeno® makes leno weaving easy ...



### Drebbing technique advantages

- Higher weaving machine productivity with speeds up to 450 rpm on rapier machines and up to 720 rpm on air-jet machines
- Easy handling and maintenance through needle bars without additional shedding device
- Normal front and rear shed
- High warp densities up to 30 threads/cm possible
- Slip resistance is up to 70% higher than plain weaves

Ground needle bar (blue) and movable needle bar (grey) create the weaving shed for the leno weave  
The reed (green) beats up the filling thread into the drebfabric

### Drebbing technique DORNIER EasyLeno® – minimum material use, maximum productivity

DORNIER's drebbing technique DORNIER EasyLeno® – minimum material use, maximum productivity Textile fabrics with leno weave are more slip resistant than fabrics with plain, twill or satin weaves. Reason: The number of crossings within a binding unit is higher and the angle of wrap on thread crossings larger. Assuming the same thread density, thread tension and friction coefficient for a plain and a drebbing weave (drebfabric), the slip resistance of the drebfabric is up to 70% higher. This means, for example, plain weaves can be redesigned as drebfabrics so that material usage can be reduced by up to 30% and productivity increased by up to 40%. Even more the color brilliance of drebfabrics is impressive: Filling yarn colors dominate and overpower the warp color so that standard warps can be used to produce different styles just through filling changes or filling effects. DORNIER's new drebbing technique achieves its advantages through innovative technology, gentle to the yarn, user-friendly, self-cleaning as well as quick in gaining experience and style changes – it's easy.

Plain weave

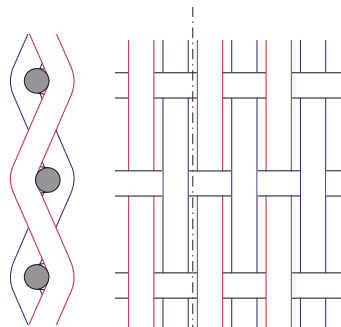

4 interlacings in a weave repeat  
(Small crossing angle)

Leno weave

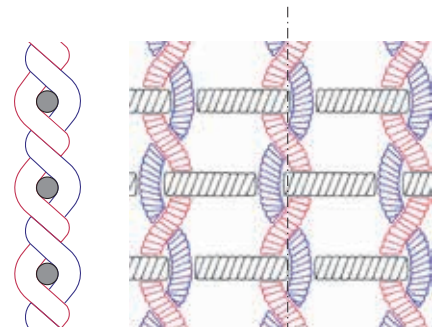

6 interlacings in a weave repeat  
(Large crossing angle)

## ... DORNIER EasyLeno®-2T creates a new textile surface - the drebfabric

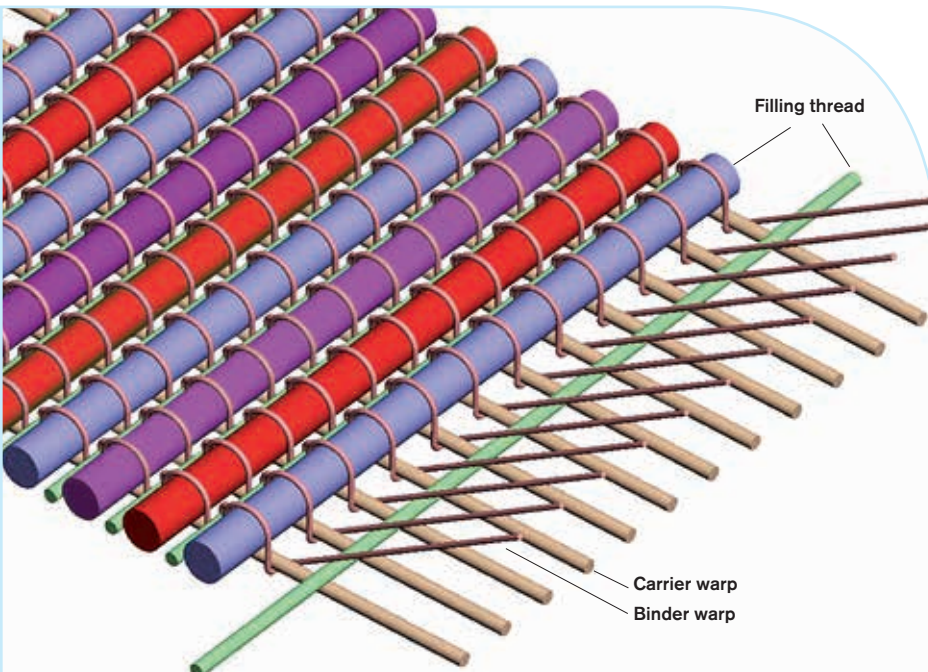

### DORNIER EasyLeno®-2T advantages

- Innovative double-face fabric
- Reduced structural elongation (filling threads and carrier threads lay straight in the drebfabric)
- Higher density level and distinctly superior color brilliance
- Relief-type fabric surfaces through different yarn counts
- Variable density level settings allow mesh-like and compressed stripes

### Drebfabric – universal in use – inherently stable, brilliant colors and tear proof

DORNIER EasyLeno®-2T processes warp ends in two systems. Different warp tensions then create an innovative drebfabric. Warp ends are crossed on the rear side which means a higher filling density can be set and the new geometry creates new attractive optical characteristics. Substituting finer threads for the binding thread allows new designs with a double-face character. Filling threads can be impacted so close to each other that a density level of 100% can be attained. The drebfabric thus shows a mock plain weave on the upper side. An over 20% increase in breaking strength has been proven thanks to decisive improvements in the stress-strain ratio.



DORNIER EasyLeno®-2T is suitable to produce fabrics with various densities because no crimping capability is required in filling direction independent of the thread density. Temple cylinders with only two needle knurls are sufficient for fabric guidance in all density settings.

Stress-strain ratio for fabrics and drebfabrics

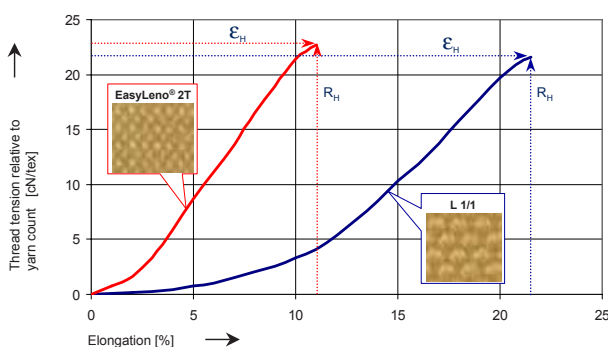

Characteristic lines for drebfabric density limits

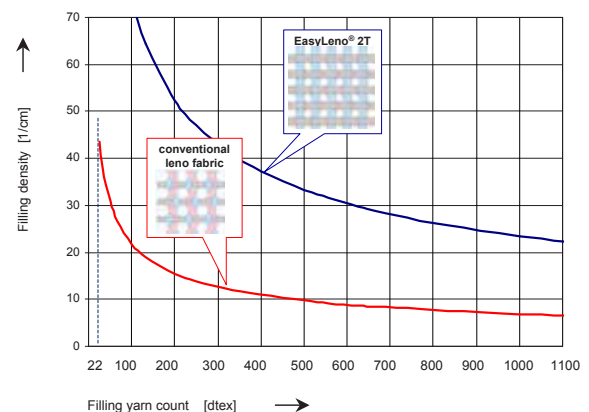

## DORNIER EasyLeno® – DORNIER EasyLeno®-2T New technology for innovative textile fabrics

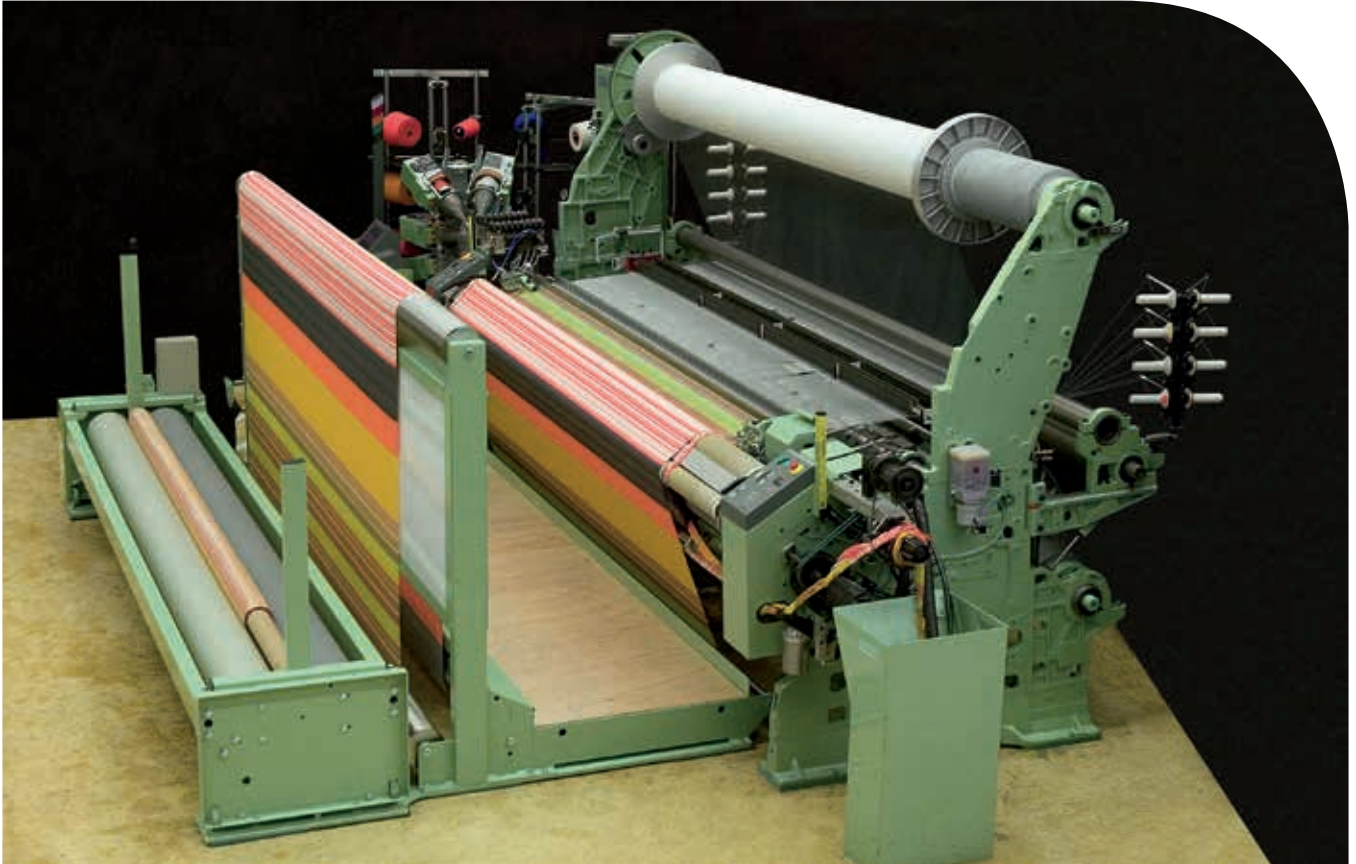

DORNIER air-jet weaving machine, fitted with leno device DORNIER EasyLeno®-2T for “dreb fabrics” from mesh-like up to 100% compressed structures

### **An innovation with potential**

Globalization has made the hard-fought market for textile fabrics even tougher. The difference made through innovation is therefore more important than ever for many manufacturers. Bearing our customers in mind, DORNIER has reacted to this challenge with groundbreaking technology for completely new leno fabric structures, the “drebbling” technique. Leno weaves may be in demand due to their transparency and slip resistance but the classical manufacturing technology with inverted leno heddles shows significant disadvantages regarding productivity, flexibility and wear. DORNIER took the task on and presented a new method: DORNIER EasyLeno®. This means: Weaving without superstructures, with needle bars instead of leno heddles, without separate shedding devices, with speeds to over 700 rpm, less wear and high efficiency during style changes. The terms “drebbling” and “dreb fabric” characterize this new style of leno weaving. DORNIER’s EasyLeno® and DORNIER’s EasyLeno®-2T technology allows you to create completely new high quality products in “drebbling” technique that cannot easily be imitated and copied.

**Lindauer DORNIER GmbH**

Rickenbacher Str. 119  
88131 Lindau, Germany  
Telephone +49 8382 7030  
Telefax +49 8382 703 1386

**American DORNIER Machinery Corp.**

P.O. Box 668865  
Charlotte, N.C. 28266, USA  
Telephone +1 704 697 3310  
Telefax +1 704 697 3379

**DORNIER Machinery India  
Private Limited**

201-A, Sangeet Plaza  
Marol Maroshi Road  
Andheri (East)  
Mumbai 400 059, India  
Telephone +91 22 292 506 74  
Telefax +91 22 292 087 60

**DORNIER Makina Ltd. Sti.**

Oruç Reis Mahallesi  
Giyimkent Sitesi 6. Sokak B64 No. 38-40  
34235 Esenler/Istanbul, Turkey  
Telephone +90 212 4266 998  
Telefax +90 212 6011 603

**DORNIER Machinery (Shanghai) Co. Ltd.**

WaiGaoQiao Tax Free Zone  
299 FuTeZhong Road  
Area B G/F Block 45  
Shanghai 200131, China  
Telephone +86 21 504 62838  
Telefax +86 21 504 62138

[www.lindauerdornier.com](http://www.lindauerdornier.com)  
[sales.wm@lindauerdornier.com](mailto:sales.wm@lindauerdornier.com)





---

# DORNIER EasyLeno<sup>®</sup>

Quality creates value

**DORNIER**

WEAVING